

stûv

**S
[21]**

The
essential
fire

The s21 model is a wood-burning insert with retractable glass. Its understated simplicity is as enviable as its warmth - the focus here is on the purity and beauty of the fire. The model comes in a number of formats, including single-sided or double-sided. Cladding - front panels and ready-to-fit - enhances the s21 so that it blends in seamlessly with its surroundings. Accessories that are both practical beautiful complete the range.

single-sided

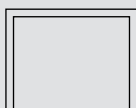

s[21]sf p.2

double-sided

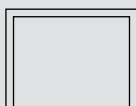

s[21]df p.14





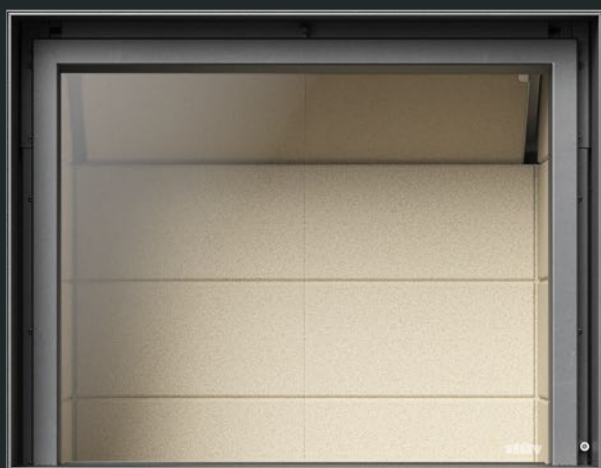

When you choose Stûv, you can enjoy guaranteed quality and simplicity.

s[21]sf

75



85

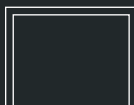

95

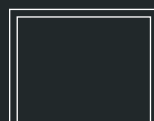

105

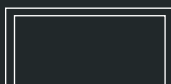

125

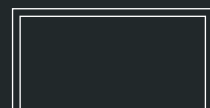

Designed to be built in, the s21 is easy to instal and straightforward to use. Totally unpretentious, it offers the perfect view of your fire.

The different cladding options available give it a stylish finish, making sure it blends in perfectly with its surroundings.

Performance*

Energy efficiency class

Energy efficiency index

Output

Output range

Nominal efficiency

Seasonal efficiency

Fine particle emissions

CO emissions

NOx emissions

COV/COG emissions



Range of wood consumption

s[21]sf

Logs - Maximum length

Weight

Standards

A	A	A
106	104	101
10 kW	13 kW	16 kW
8 - 11 kW	8 - 14 kW	10 - 18 kW
80 %	78 %	76 %
70 %	69 %	67 %
26 mg/Nm ³	22 mg/Nm ³	18 mg/Nm ³
0,07 % / 910 mg/Nm ³	0,08 % / 1012 mg/Nm ³	0,09 % / 1113 mg/Nm ³
116 mg/Nm ³	113 mg/Nm ³	111 mg/Nm ³
66 mg/Nm ³	57 mg/Nm ³	49 mg/Nm ³
2,2 - 3,1 kg/h	2,3 - 4,0 kg/h	2,9 - 5,3 kg/h
75	85	95
		
50 cm	60 cm	70 cm
182 kg	234 kg	292 kg
EcoDesign 2022	EcoDesign 2022	EcoDesign 2022

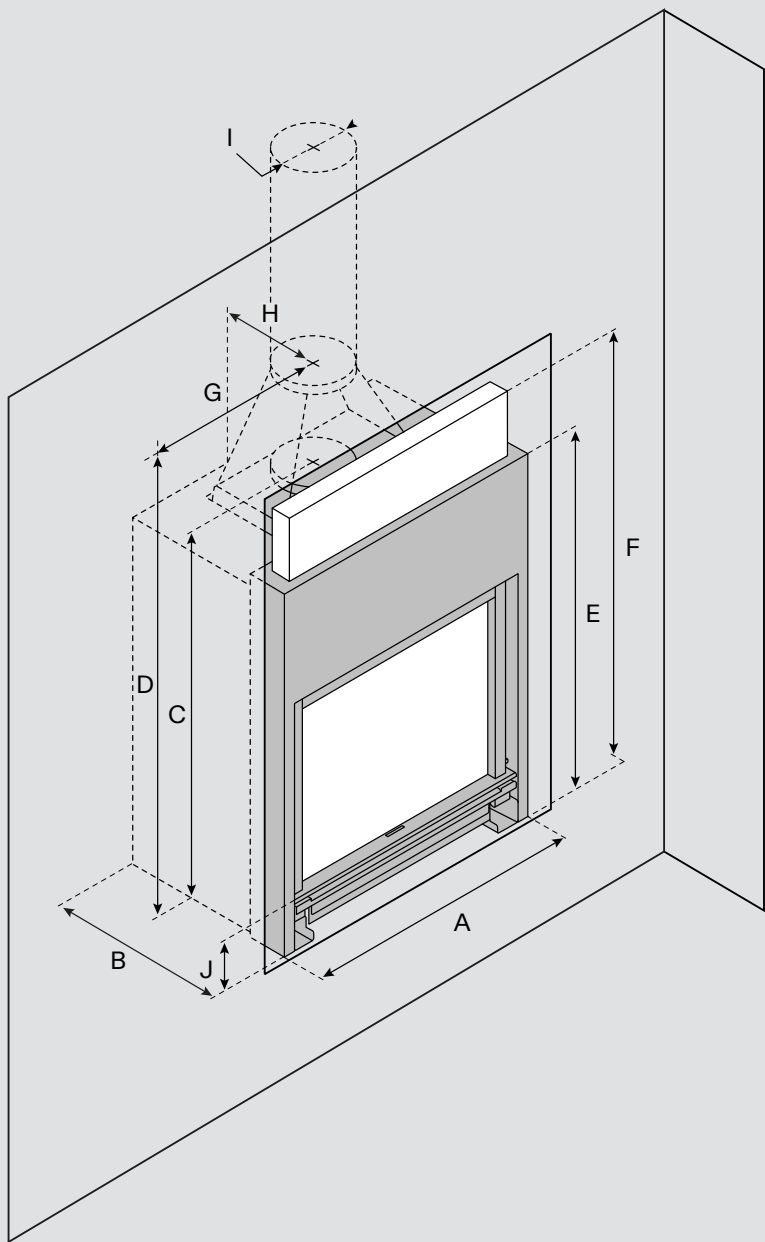

s[21]sf

	75	85	95
[A] Width	750 mm	850 mm	950 mm
[B] Depth	490 mm	540 mm	590 mm
[C] Height low outlet	1070 mm	1180 mm	1290 mm
[D] Height high outlet	1211 mm	1320 mm	1430 mm
[E] Device height without full raise	1005 mm	1115 mm	1225 mm
[F] Device height with full raise	1137 mm	1295 mm	1455 mm
[G] Flue axis - side	375 mm	425 mm	475 mm
[H] Flue axis - rear	186 mm	201 mm	221 mm
[I] Smoke outlet diameter	180 mm	200 mm	250 mm
[J] Damper shelf height	158 mm	158 mm	158 mm
Ø External air connection	100 mm	100 mm	100 mm
Optional ventilation kit	✓	✓	✓

Glass

	75	85	95
Width	570 mm	670 mm	770 mm
Height	456 mm	535 mm	615 mm

* Caution: make sure you add the insulation thicknesses defined by your local regulations to the dimensions of the recess.

The device must be properly installed by an authorised dealer-installer.

Performance*

Energy efficiency class

Energy efficiency index

Output

Output range

Nominal efficiency

Seasonal efficiency

Fine particle emissions

CO emissions

NOx emissions

COV/COG emissions

Range of wood consumption

s[21]sf

Logs - Maximum length

Weight

Standards

A+	A
112	101
19 kW	20 kW
7 - 19 kW	11 - 23 kW
84 %	76 %
74 %	67 %
20 mg/Nm ³	22 mg/Nm ³
0,09 % / 1122 mg/Nm ³	0,10 % / 1299 mg/Nm ³
48 mg/Nm ³	99 mg/Nm ³
43 mg/Nm ³	99 mg/Nm ³
1,9 - 5,1 kg/h	3,2 - 6,6 kg/h

105	125
-----	-----

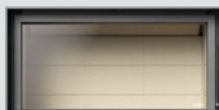

80 cm	100 cm
224 kg	305 kg
EcoDesign 2022	EcoDesign 2022

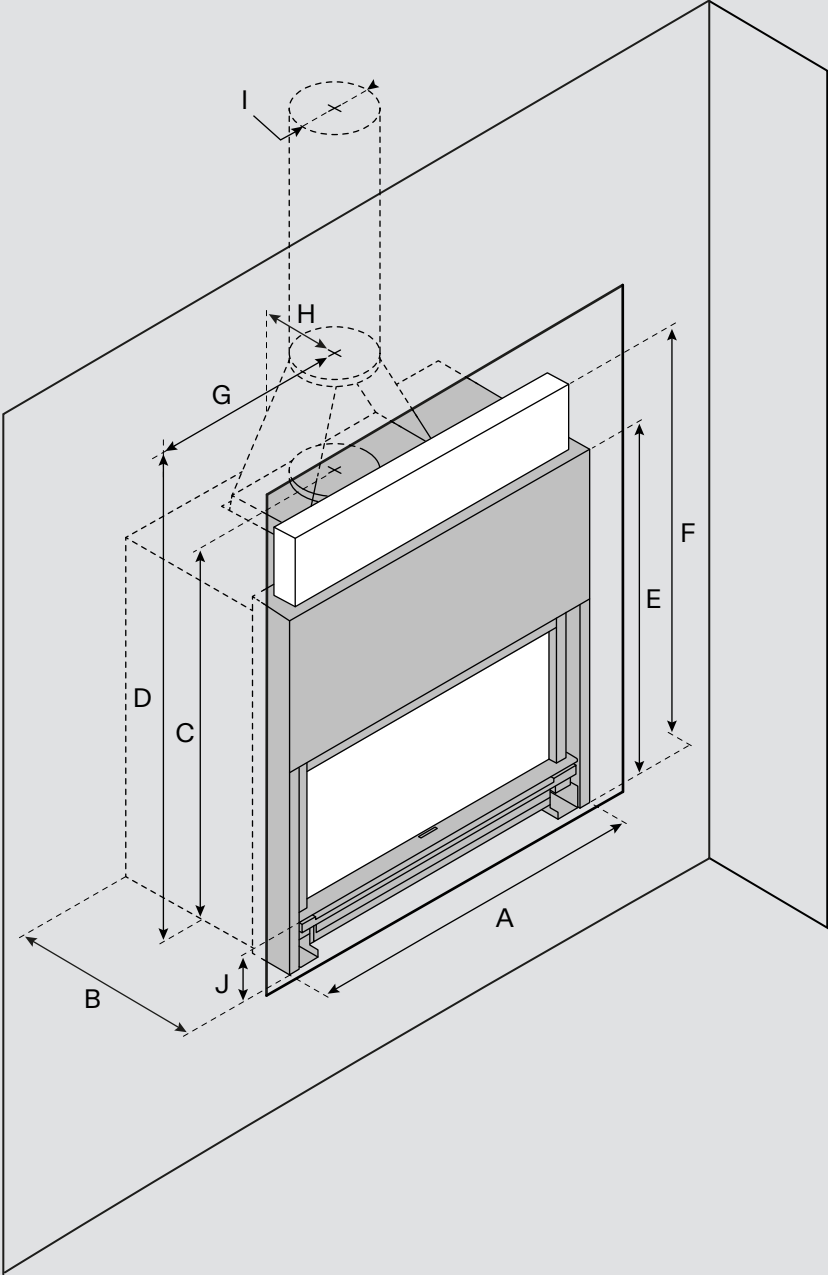

s[21]sf

	105	125
[A] Width	1050 mm	1250 mm
[B] Depth	496 mm	563 mm
[C] Height low outlet	1105 mm	1180 mm
[D] Height high outlet	1245 mm	1320 mm
[E] Device height without full raise	1040 mm	1115 mm
[F] Device height with full raise	1040 mm	1295 mm
[G] Flue axis - side	525 mm	625 mm
[H] Flue axis - rear	201 mm	221 mm
[I] Smoke outlet diameter	200 mm	300 mm
[J] Damper shelf height	158 mm	158 mm
Ø External air connection	100 mm	-
Optional ventilation kit	✓	✓

Glass

	105	125
Width	870 mm	1070 mm
Height	400 mm	535 mm

* Caution: make sure you add the insulation thicknesses defined by your local regulations to the dimensions of the recess.

The device must be properly installed by an authorised dealer-installer.

A pure line

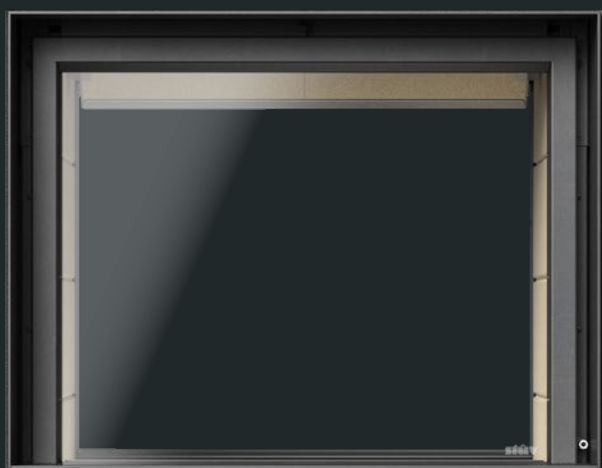

When you choose Stûv, you are keeping the flames of togetherness burning.

s[21]df

75



85

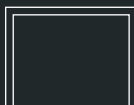

95

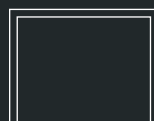

125

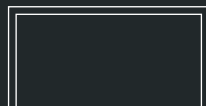

The double-sided s21 has retractable glass on both sides. Installed between two rooms, you can enjoy looking at the fire from either side.

The different cladding options available give it a stylish finish, making sure it blends in perfectly with its surroundings, whatever the architecture.

Performance*

Energy efficiency class

Energy efficiency index

Output

Output range

Nominal efficiency

Seasonal efficiency

Fine particle emissions

CO emissions

NOx emissions

COV/COG emissions



Range of wood consumption

s[21]df

Logs - Maximum length

Weight

Standards

A	A	A
99	99	100
18 kW	24 kW	26 kW
9 - 19 kW	11 - 24 kW	12 - 27 kW
75 %	75 %	75 %
65 %	65 %	66 %
30 mg/Nm ³	15 mg/Nm ³	30 mg/Nm ³
0,08 % / 997 mg/Nm ³	0,06 % / 775 mg/Nm ³	0,07 % / 813 mg/Nm ³
127 mg/Nm ³	57 mg/Nm ³	111 mg/Nm ³
86 mg/Nm ³	23 mg/Nm ³	88 mg/Nm ³
2,7 - 5,7 kg/h	3,3 - 6,3 kg/h	3,6 - 8,0 kg/h
75	85	95
		
50 cm	60 cm	70 cm
187 kg	236 kg	297 kg
EcoDesign 2022	EcoDesign 2022	EcoDesign 2022

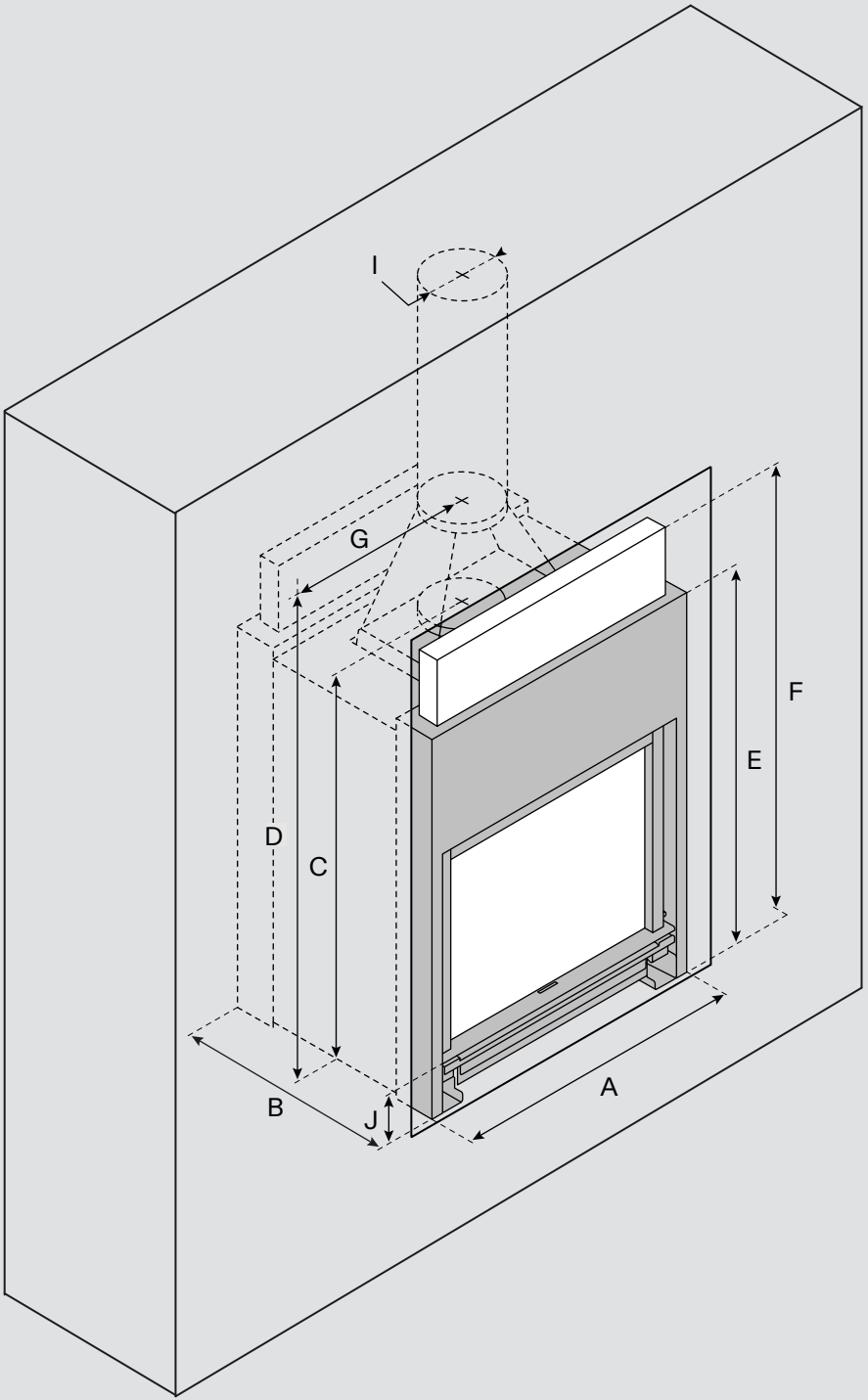

s[21]df

	75	85	95
[A] Width	750 mm	850 mm	950 mm
[B] Depth	670 mm	670 mm	670 mm
[C] Height low outlet	1070 mm	1180 mm	1290 mm
[D] Height high outlet	1211 mm	1320 mm	1430 mm
[E] Device height without full raise	1005 mm	1115 mm	1225 mm
[F] Device height with full raise	1136 mm	1295 mm	1455 mm
[G] Flue axis - side	375 mm	425 mm	475 mm
[H] Flue axis - rear	336 mm	336 mm	336 mm
[I] Smoke outlet diameter	250 mm	250 mm	250 mm
[J] Damper shelf height	158 mm	158 mm	158 mm
Ø External air connection	100 mm	100 mm	100 mm
Optional ventilation kit	✓	✓	✓

Glass

	75	85	95
Width	570 mm	670 mm	770 mm
Height	456 mm	535 mm	615 mm

* Caution: make sure you add the insulation thicknesses defined by your local regulations to the dimensions of the recess.

The device must be properly installed by an authorised dealer-installer.

Performance*

Energy efficiency class

Energy efficiency index

Output

Output range

Nominal efficiency

Seasonal efficiency

Fine particle emissions

CO emissions

NOx emissions

COV/COG emissions

Range of wood consumption

s[21]df

Logs - Maximum length

Weight

Standards

A

99

27 kW

14 - 27 kW

75 %

65 %

14,3 mg/Nm³

0,10 % / 1230 mg/Nm³

104 mg/Nm³

69 mg/Nm³

4,2 - 8,1 kg/h

125

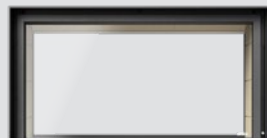

100 cm

310 kg

EcoDesign 2022

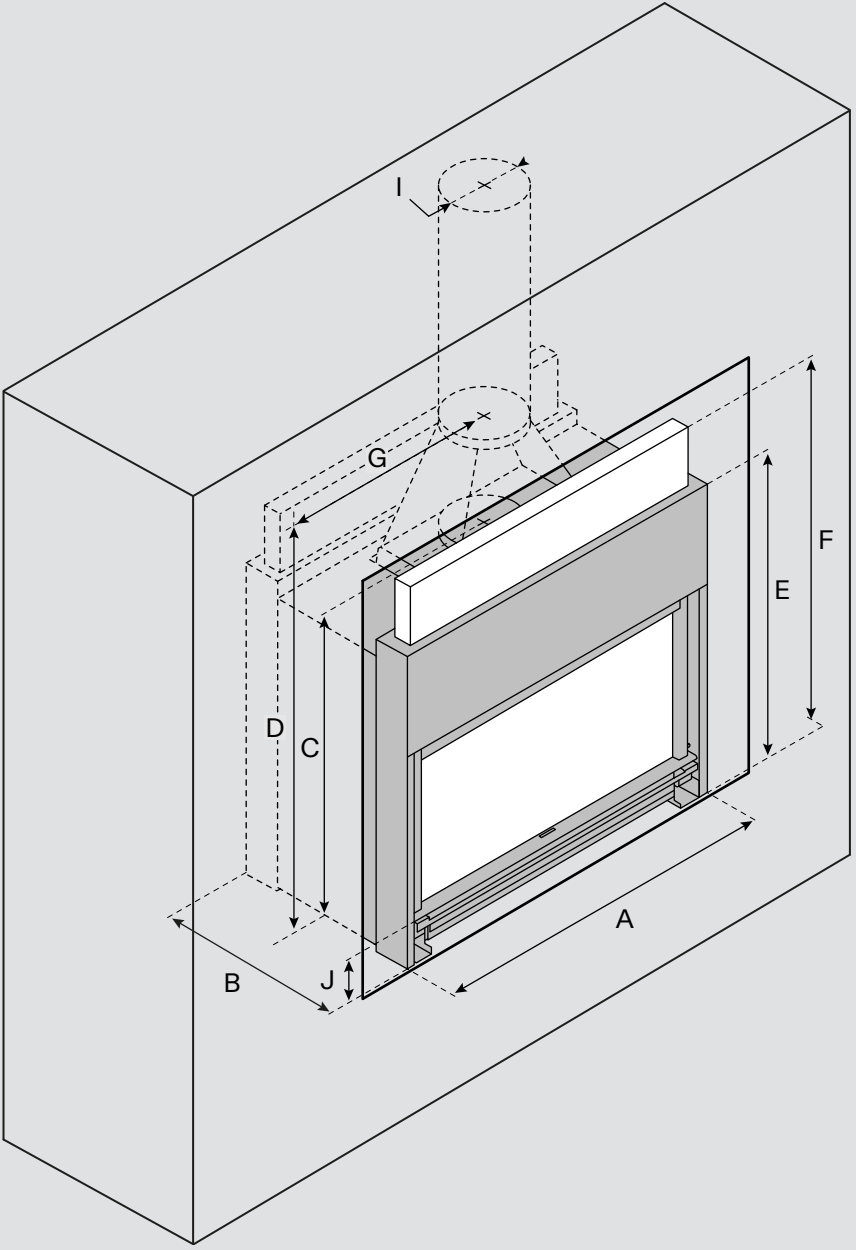

s[21]df

125

[A] Width	1250 mm
[B] Depth	670 mm
[C] Height low outlet	1180 mm
[D] Height high outlet	1320 mm
[E] Device height without full raise	1115 mm
[F] Device height with full raise	1295 mm
[G] Flue axis - side	625 mm
[H] Flue axis - rear	336 mm
[I] Smoke outlet diameter	300 mm
[J] Damper shelf height	158 mm
Ø External air connection	-
Optional ventilation kit	✓

Glass

125

Width	1185 mm
Height	535 mm

* Caution: make sure you add the insulation thicknesses defined by your local regulations to the dimensions of the recess.

The device must be properly installed by an authorised dealer-installer.

Share the
warmth



		75	85	95	105	125
--	--	----	----	----	-----	-----

Thin frame

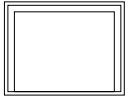

W	692	792	892	992	1192
H	532	611	691	476	611

Applied frame

4 sides

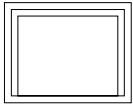

W	782	882	982	1082	1282
H	626	705	785	570	705

Frames

The frames conceal the corners of the masonry around the fireplace, making it look wider. They come in thin and applied versions. Frames are available in Stûv Grey.



	75	85	95	105	125
--	----	----	----	-----	-----

SF1

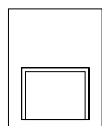

W	1084	1184	1284	-	1584
H	1270	1370	1490	-	1370
D	200	200	200	-	200

SF1 air

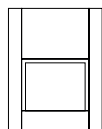

W	1084	1184	1284	-	-
H	1430	1530	1650	-	-
D	200	200	200	-	-

SF2

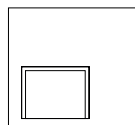

W	1584	1684	1784	1884	2084
H	1270	1370	1490	1164	1370
D	200	200	200	200	200

SF2 air

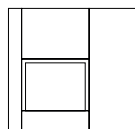

W	1584	1684	1784	1884	-
H	1430	1530	1650	1325	-
D	200	200	200	200	-

Front panels

The front panels make installation easier: they conceal the whole recess, avoiding the need for any masonry work. They are available in Stův Grey, Dark Grey, Concrete Grey, white and rust.

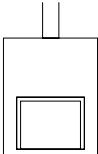

		75	85	95	105	125
SF1 	W	1084	1184	1284	-	1584
	H	1270	1370	1490	-	1370
	D	570	620	670	-	640

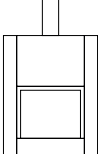
SF1 air 	W	1084	1184	1284	-	-
	H	1430	1530	1650	-	-
	D	570	620	670	-	-

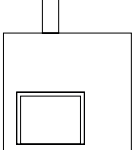
SF2 	W	1584	1684	1784	1884	2084
	H	1270	1370	1490	1164	1370
	D	570	620	670	570	640

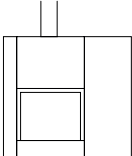
SF2 air 	W	1584	1684	1784	1884	-
	H	1430	1530	1650	1325	-
	D	570	620	670	570	-

Ready to fit single-faced

The ready-to-fit version is a great alternative for your wood-burner. It can be installed without the need for any major work, and incorporates all the features such as a log store and a convection air outlet. It is available in Stûv Grey, Dark Grey, Concrete Grey, white and rust.

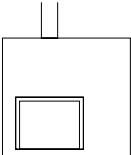

	75	85	95	125	
DF2					
 A schematic diagram of a wood burner with a chimney pipe on top and a firebox at the bottom.	W	1584	1684	1784	2084
	H	1270	1370	1490	1370
	D	800	800	800	800

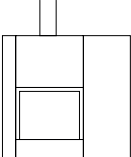
DF2 air					
 A schematic diagram of a wood burner with a chimney pipe on top, a firebox, and a side panel on the right.	W	1584	1684	1784	-
	H	1430	1530	1650	-
	D	800	800	800	-

Ready to fit double-faced

The ready-to-fit version is a great alternative for your wood-burner. It can be installed without the need for any major work, and incorporates all the features such as a log store and a convection air outlet. It is available in Stûv Grey, Dark Grey, Concrete Grey, white and rust.



Accessories

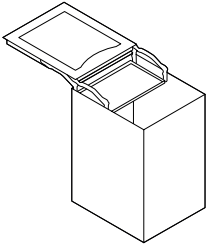

Mobilobox

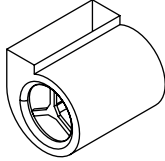

Fan

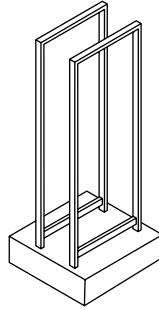

Log trolley

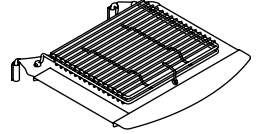

BBQ kit

Colours

The cladding colours for the front panels and ready-to-fit stoves have been carefully chosen to transcend time, offering elegance and understated style. If you'd like more customisation options, other colours are available. Please speak to your authorised dealer.

Stöv Grey ●

White ○

Rust ●

Dark Grey ●

Concrete Grey ●

Rust

The rust finish is created thanks to the natural oxidisation process in a controlled environment. This process takes several weeks of work to achieve the desired effect. Just like works of art, the rust cladding options are unique, offering inspirational sophistication.

REMOVE

FUNCTIONS



s [21]

[SIMPLE] Simplicity is the keyword when it comes to designing our products. This is true of their shape, installation, usage and maintenance. [PANORAMIC]

The expansive glass offers a generous view of the fire. There's no frame at the bottom of the glass to get in the way of the view of the

flames. [POWERFUL] Fire bricks adorn the combustion chamber so a lot of heat is distributed very quickly. [EFFECTIVE] The device uses a natural convection system. It can also be fitted with a fan to circulate the warm air even more. [UNIQUE] All the mechanical elements are fitted in the door. This patented door system means that it can be retracted and tipped; it also guarantees a tight seal, which makes sure that the stove is efficient. [INGENIOUS] The glass slides upwards for loading and for barbecue mode. The door can also tip forward so that the glass can be cleaned and the stove maintained. [MULTIFACETED] The different configurations and sizes of insert available, as well as the huge range of cladding options mean that your stove can blend in with all sorts of different architectural styles. [CLEAN] Air is drawn over the glass for a flawless view of the flames.

The Stûv families

s[6]



s[16]



s[30]



s[μ M]



s[21]



s[22]



s[P10]



s[P20]



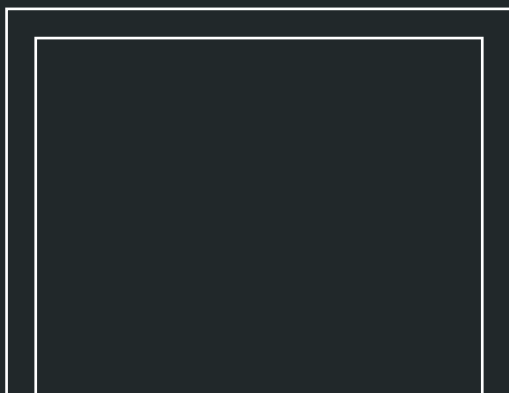

Documents and photos are not contractual. Stûv reserves the right to make changes without notice.
This catalogue has been carefully compiled; however, we decline all responsibility for any errors.

Stûv fireplaces are designed and manufactured by Stûv sa - Belgium - stuv.com