

**stuv**

**S [22]**

The  
essential  
fire

The s22 range of wood-burner inserts stands out thanks to its technical and aesthetic sophistication. These stoves with retractable glass feature a highly advanced seal and offer an uninterrupted view of the fire. They have been designed to maximise heating performance and enjoyment. They have chameleon like properties, and the 3 sizes available, as well as a wide range of cladding options, mean that they will blend in seamlessly with interior designs where every details counts. Accessories that are both practical beautiful complete the range.

## single-sided

---

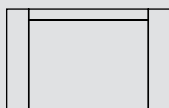

s[22]sf p.2

## double-sided

---

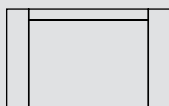

s[22]df p.10







When you choose Stûv, satisfaction is guaranteed.

## s[22]sf

70

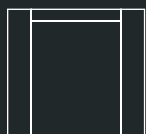

90

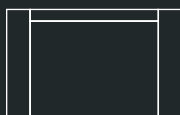

110

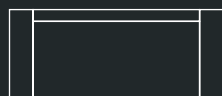

The single-sided s22 is a highly effective wood-burning insert with sophisticated aesthetics. Not a single detail interrupts your view of the flames.

Boasting technical ingenuity, there are also a huge number of customisation options, and any kind of material, including wood, can be used closer to the fire than you might expect

---

Performance\*

Energy efficiency class

---

Energy efficiency index

---

Output

---

Output range

---

Nominal efficiency

---

Seasonal efficiency

---

Fine particle emissions

---

CO emissions

---

NOx emissions

---

COV/COG emissions

---

Range of wood consumption

---

s[22]sf

---



Logs - Maximum length

---

Weight

---

Standards

A	A+	A
107	108	70
11 kW	15 kW	16,5 kW
4 - 12 kW	5 - 16 kW	5 - 18 kW
80 %	80 %	80 %
71 %	71 %	70 %
20 mg/Nm <sup>3</sup>	12 mg/Nm <sup>3</sup>	26 mg/Nm <sup>3</sup>
0,08% / 969 mg/Nm <sup>3</sup>	0,08 % / 979 mg/Nm <sup>3</sup>	0,09 % / 1066 mg/Nm <sup>3</sup>
118 mg/Nm <sup>3</sup>	100 mg/Nm <sup>3</sup>	103 mg/Nm <sup>3</sup>
54 mg/Nm <sup>3</sup>	56 mg/Nm <sup>3</sup>	69 mg/Nm <sup>3</sup>
1,2 - 3,8 kg/h	1,6 - 5,0 kg/h	1,6 - 5,6 kg/h
70	90	110
		
33 cm	50 cm	80 cm
238 kg	265 kg	277 kg
EcoDesign 2022 DEFRA	EcoDesign 2022 DEFRA	EcoDesign 2022 DEFRA

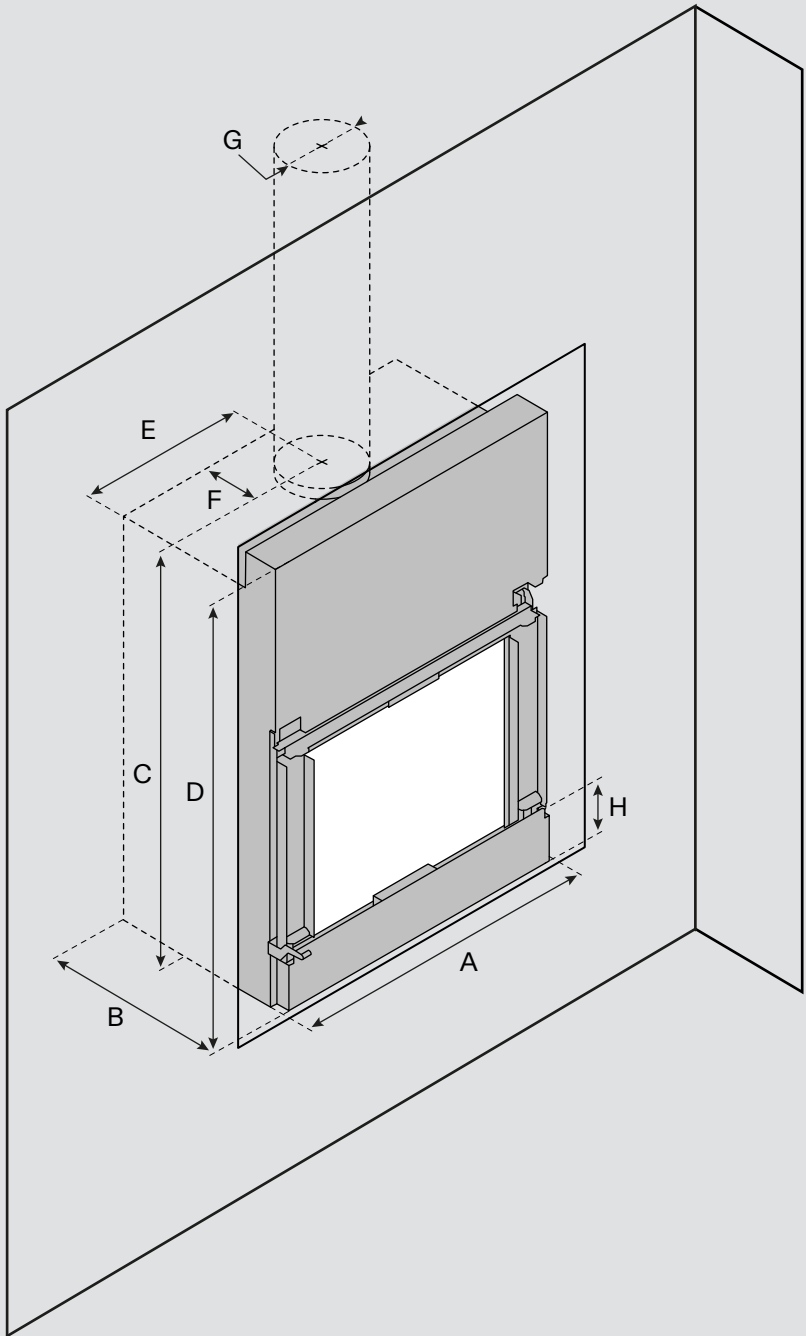

# s[22]sf

	70	90	110
[A] Width	710 mm	910 mm	1110 mm
[B] Depth	505 mm	505 mm	505 mm
[C] Height	1267 mm	1197 mm	1097 mm
[D] Device height	1412 mm	1272 mm	1072 mm
[E] Flue axis - side	355 mm	455 mm	555 mm
[F] Flue axis - rear	213 mm	213 mm	213 mm
[G] Smoke outlet diameter	180 mm	200 mm	200 mm
[H] Damper shelf height	160 mm	160 mm	160 mm
Ø External air connection	100 / 160 mm	100 / 160 mm	100 / 160 mm
Optional ventilation kit	✓	✓	✓

## Glass

	70	90	110
Width	470 mm	670 mm	870 mm
Height	570 mm	500 mm	400 mm

\* Caution: be sure to add the insulation thicknesses defined by your local regulations to the dimensions of the recess.

The appliance must be professionally installed by an authorised dealer/installer.



Clean  
lines



When you choose Stûv, you can enjoy guaranteed quality.

## s[22]df

90

110

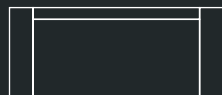
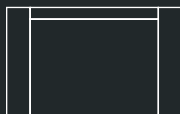

The double-sided s22 has retractable glass on both sides. Installed between two rooms, you can enjoy looking at the fire from either side.

The different cladding options available give it a stylish finish, making sure it blends in perfectly with its surroundings, whatever the architecture.

---

Performance\*

Energy efficiency class

---

Energy efficiency index

---

Output

---

Output range

---

Nominal efficiency

---

Seasonal efficiency

---

Fine particle emissions

---

CO emissions

---

NOx emissions

---

COV/COG emissions

---

Range of wood consumption

---

s[22]df

---

---

Logs - Maximum length

---

Weight

---

Standards

A+	A
71	67
17 kW	20 kW
7 - 19 kW	8 - 23 kW
80 %	77 %
71 %	67 %
17 mg/Nm <sup>3</sup>	25 mg/Nm <sup>3</sup>
0,09 % / 1125 mg/Nm <sup>3</sup>	0,08 % / 1010 mg/Nm <sup>3</sup>
115 mg/Nm <sup>3</sup>	117 mg/Nm <sup>3</sup>
66 mg/Nm <sup>3</sup>	45 mg/Nm <sup>3</sup>
2,2 - 5,9 kg/h	2,5 - 5,1 kg/h

90	110
----	-----



50 cm	80 cm
296 kg	314 kg
EcoDesign 2022 DEFRA	EcoDesign 2022 DEFRA

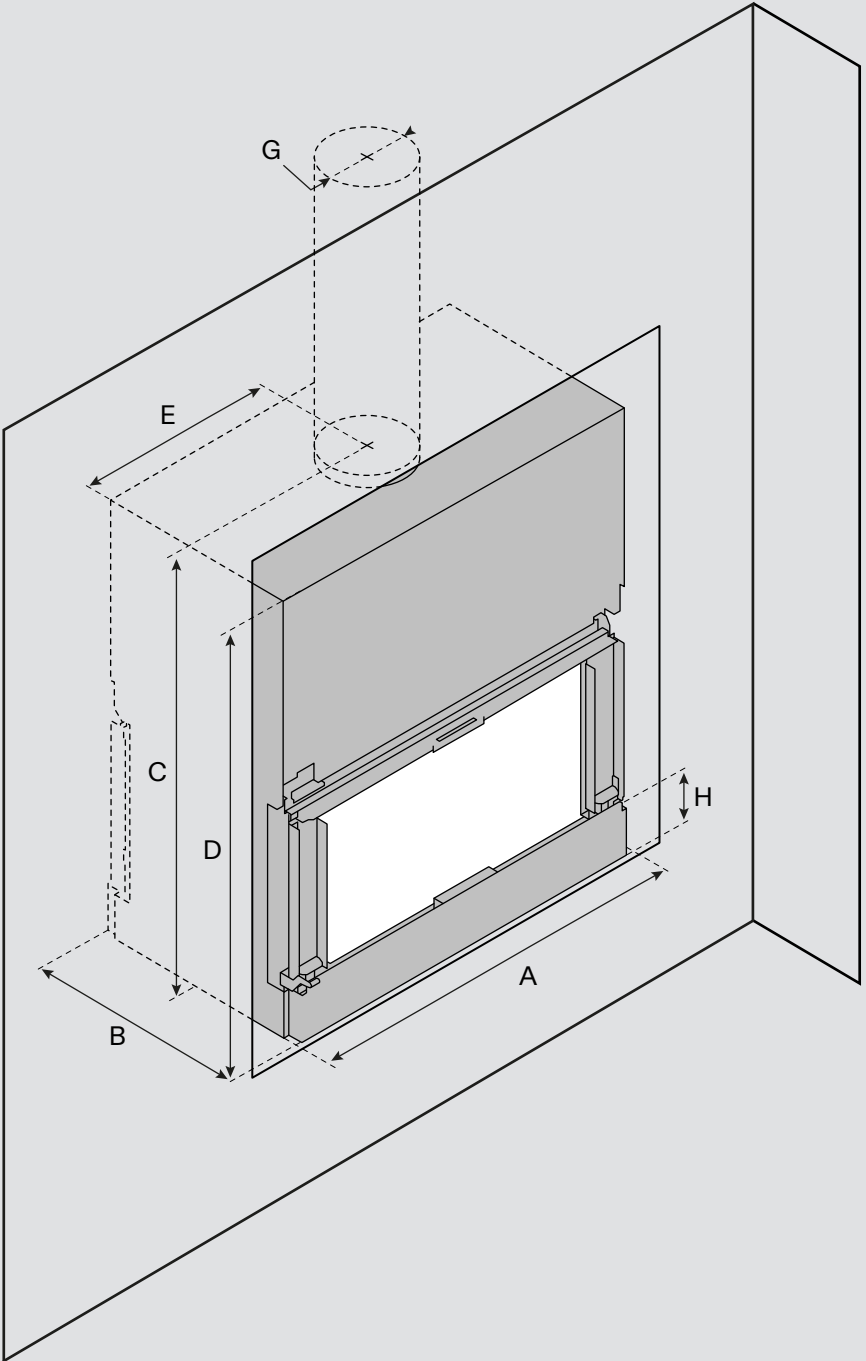

# s[22]df

	90	110
[A] Width	910 mm	1110 mm
[B] Depth	584 mm	584 mm
[C] Height	1385 mm	1285 mm
[D] Device height	1365 mm	1265 mm
[E] Flue axis - side	455 mm	555 mm
[F] Flue axis - rear	320 mm	320 mm
[G] Smoke outlet diameter	250 mm	250 mm
[H] Damper shelf height	165 mm	165 mm
Ø External air connection	100 / 160 mm	100 / 160 mm
Optional ventilation kit	-	-

## Glass

	90	110
Width	670 mm	870 mm
Height	500 mm	400 mm

\* Caution: be sure to add the insulation thicknesses defined by your local regulations to the dimensions of the recess.

The appliance must be professionally installed by an authorised dealer/installer.



sf 70

sf 90

sf 110

df 90

df 110

## S4

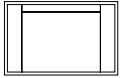

W	735	935	1135	935	1135
H	675	605	505	605	505
D	635	635	635	845	845

## C2

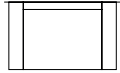

W	810	1010	1210	-	-
H	690	590	490	-	-
D	566	566	566	-	-

## D3



W	1700	1900	1900	-	-
H	665	590	495	-	-
D	510	510	510	-	-

## D4

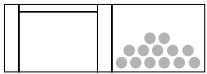

W	1700	1900	1900	1900	1900
H	665	595	495	595	495
D	612	612	612	800	800

## Frames

---

The frames conceal the corners of the masonry around the fireplace, making it look wider. Some models also offer a corner finish or a recess for storing wood, with customised widths available. Frames are available in Dark Grey.

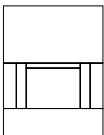

		sf 70	sf 90	sf 110	df 90	df 110
	W	795	995	1195	995	1195
	H	1770	1730	1530	1605	1505
	D	575	575	575	714	714

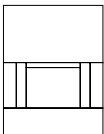
	W	-	1074	1274	-	-
	H	-	1610	1510	-	-
	D	-	570	570	-	-

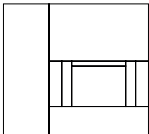
	W	-	1635	1835	-	-
	H	-	1610	1510	-	-
	D	-	570	570	-	-

## Front panels

The front panels make installation easier: they conceal the whole recess, avoiding the need for any masonry work. Front panels are available in Stûv Grey, Dark Grey, Concrete Grey, white and rust.



---

sf 90

sf 110

df 90

df 110

### SF1 and DF1

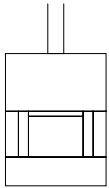

	sf 90	sf 110	df 90	df 110
W	1074	1274	1074	1274
H	1610	1510	1610	1510
D	580	580	712	712

### SF2 and DF2

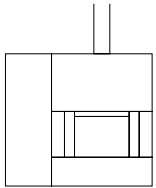

	sf 90	sf 110	df 90	df 110
W	1635	1835	1635	1835
H	1610	1510	1610	1510
D	580	580	712	712

### DF7

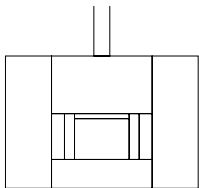

	sf 90	sf 110	df 90	df 110
W	-	-	2196	2396
H	-	-	1610	1510
D	-	-	712	712

---

## Ready-to-fit

The ready-to-fit version is a great alternative for your wood-burner. It can be installed without the need for any major work, and incorporates all the features such as a log store and a convection air outlet. Ready-to-fit models are available in Stûv Grey, Dark Grey, Concrete Grey, white and rust.



## Accessories

---

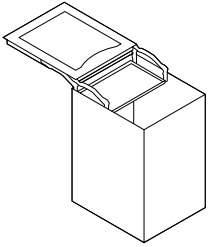

Mobilobox

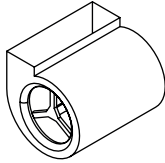

Fan

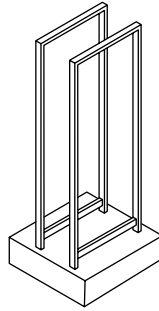

Log trolley

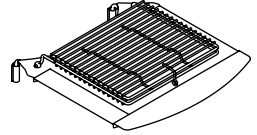

BBQ kit

## Colours

---

The cladding colours for the front panels and ready-to-fit stoves have been carefully chosen to transcend time, offering elegance and understated style. If you'd like more customisation options, other colours are available. Please speak to your authorised dealer.

Stöv Grey ●

White ○

Rust ●

Dark Grey ●

Concrete Grey ●

## Rust

---

The rust finish is created thanks to the natural oxidisation process in a controlled environment. This process takes several weeks of work to achieve the desired effect. Just like works of art, the rust cladding options are unique, offering inspirational sophistication.

REMOVE

# FUNCTIONS



# s [22]

[SIMPLE] Simplicity is the keyword when it comes to designing our products. This is true of their shape, installation, usage and maintenance. [ARCHITECTURAL] The insert is available in a range of formats and configurations to suit a wide range of projects. The cladding

options make installation easier, and offer lots of possibilities in terms of materials used close to the stove. [POWERFUL] Fire bricks adorn the combustion chamber so a lot of heat is distributed very quickly. [EFFICIENT] The device uses a natural convection system. It can also be fitted with a fan to circulate the warm air even more. [INNOVATIVE] The runners and moving mechanism for the glass are fitted in the frame of the door, making them immediately accessible. This patented Stûv technology is invisible, offering a view of the whole fire while also guaranteeing a highly advanced seal. [INGENIOUS] The glass slides upwards for loading and for barbecue mode. The door can also tip forward to make it easier to clean the inside of the glass. [EFFECTIVE] The air channels guarantee effective combustion and the damper can be used to set the power within a wide range, depending on your needs. [CLEAN] Air is drawn over the glass for a flawless view of the flames.

---

# The Stûv families

s[6]



s[16]



s[30]



s[ $\mu$ M]



---

s[21]



s[22]



s[P10]



s[P20]



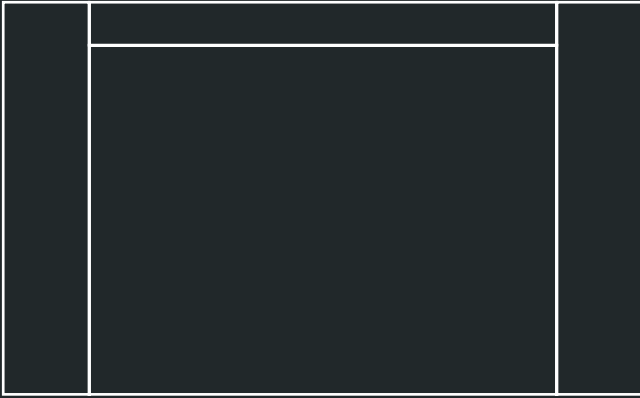

Documents and photos are not contractual. Stûv reserves the right to make changes without notice.  
This catalogue has been carefully compiled; however, we decline all responsibility for any errors.

Stûv fireplaces are designed and manufactured by Stûv sa - Belgium - [stuv.com](http://stuv.com)